

# INSTRUCTION BOOKLET

**BUILT-IN HOB**



## Important warning and advice for usage

***IMPORTANT!*** This booklet is a fundamental part of the appliance it should be preserved whole and at hand throughout the hob's lifespan. We recommend that this booklet and all the instructions within it are read carefully before using the appliance. Keep the spare parts supplied in a safe place. The appliance is to be installed by qualified personnel respecting the norms in force. This appliance is for domestic use and has been built to carry out the following functions: cooking and heating food. Any other use is considered improper.

*The manufacturer is not responsible for bad installation, tampering, unskilled use and usage other than that it is intended for.*

- ◆ Check that the product has not been damaged during transport.
- ◆ Packing elements (plastic bags, expanded polystyrene, nylon etc) are potentially dangerous and must be kept away from children.
- ◆ Packing is made up of recyclable material and is marked by the  symbol. **Do not on dispose of it in the environment.**
- ◆ This appliance is only to be used by adults. **Make sure the children do not touch the commands or play with the appliance.**
- ◆ Installation and all gas/electric connections must be carried out by qualified personnel, fully respecting the safety norms and laws in force, on the basis of the instructions supplied by the manufacturer.
- ◆ Electricians are only safe when the product is connected to an efficient earthing system.
- ◆ It is risky to modify or try to modify the appliance. In the case of faults, do not attempt reparation but ask for assistance from a qualified technician.
- ◆ Having used the hob, make sure that the knob indicator is on the off position and turn off the main gas distribution valve or the cylinder valve.
- ◆ If you decide not to use this appliance it must be rendered unusable according to health and environmental protection laws before being taken to the recyclable waste disposal; the parts that may be dangerous to children must be made
- ◆ The identification plate with its technical data is in a visible position under the housing and attached to this booklet. **The plate under the housing must never be removed.**
- ◆ The illustrations for using the appliance are in the final pages of this booklet.

## Declaration of conformity

This appliance conforms to the following CE directives

- 90/396/CEE "Gas apparatus"
- 73/23/CEE "Low voltage"
- 89/336/CEE "Electromagnetic compatibility"
- 93/68/CEE "General Norms"
- 89/109/CEE "Materials or objects that can come into contact with foodstuffs"

These instructions are only valid for destination countries with the identification symbols shown in the booklet and on the appliance.

## GLASS COVER

If the appliance has a glass cover, please take the following precautions:

- ◆ Do not place hot pots on the cover when it is closed.
- ◆ Remove any liquid that has spilled onto it before opening it.
- ◆ It could break if heated. Turn all the burners and the electric plates off and wait for them to cool before lowering the cover.

## HOB CHARACTERISTICS

### Warning:

This appliance is the type for being built into furniture.

- ◆ The installation class is 3 for the gas parts and Y for the electric parts.
- ◆ Furniture must be resistant to temperatures of at least 90°C.
- ◆ See the relative paragraph and drawings for correct installation.
- ◆ Using a gas cooking appliance causes heat and humidity in the location where it is installed. Make sure that the kitchen is aired properly: keep natural aeration orifices open or install a mechanical aeration device (ventilation hood). Intensive and long use of the appliance will need further aeration, opening a window for example, or more efficient aeration such as increasing the hood speed.

This booklet is suitable for various hobs. You can see your **model** (Mod. Tc) on the plate. You will see how your appliance is made up from its model number, the instructions in the following paragraph and the figures at the back of the booklet (Fig1 to 26)

Example:

Marchio		
Type : P . . . .	kW: 0.15	
Mod TC: <b>P****L4</b>	XX-X-X	230 V ~ 50/60 Hz

## MODELS

### 60cm hob with front commands

#### **Mod: P6S (\*\*)** F4 (Fig. 1)

1. Semi-rapid front burner (SR)
2. Semi-rapid back burner (SR)
3. Rapid burner (R)
4. Auxiliary burner (A)

#### **Mod: P6 (\*\*)** F2 (Fig. 2)

1. Semi-rapid front burner (SR)
2. Semi-rapid back burner (SR)
3. Auxiliary burner(A)
4. Triple-crown burner / TC)

#### **Mod: P6 (\*\*)** F1 (Fig. .3)

1. Semi-rapid front burner (SR)
2. Electric plate ø 145
3. Rapid burner(R)
4. Auxiliary burner(A)

#### **Mod: P6 (\*\*)** FY (Fig. 4)

1. Auxiliary burner(A)
2. Triple-crown burner (TC)
3. Semi-rapid back burner (SR)
4. Semi-rapid left burner(SR)

### 70cm hob with front commands

#### **Mod: P7 (\*\*)** F5 (Fig. 5)

1. Auxiliary burner(A)
2. Rapid burner(R)
3. Semi-rapid back burner (SR)
4. Semi-rapid front burner (SR)
5. Triple-crown burner (TC)

#### **Mod: P7 (\*\*)** F4 (Fig. 6)

1. Auxiliary burner(A)
2. Rapid burner(R)
3. Semi-rapid back burner (SR)
4. Semi-rapid front burner (SR)

#### **Mod: P7 (\*\*)** F3 (Fig. 7)

1. Triple-crown burner (TC)
2. Semi-rapid back burner (SR)
3. Auxiliary burner(A)

## **75cm hob with front commands**

### **Mod: P8 (\*\*)*F5 (Fig. 8)***

1. Auxiliary burner(A)
2. Rapid burner(R)
3. Semi-rapid back burner (SR)
4. Semi-rapid front burner (SR)
5. DUAL burner (DUAL)

### **Mod: P8 (\*\*)*F5 (Fig. 9)***

1. Auxiliary burner(A)
2. Semi-rapid back burner (SR)
3. Rapid burner(R)
4. Semi-rapid front burner (SR)
5. DUAL burner (DUAL)

### **Mod: P8 (\*\*)*FU (Fig. 10)***

1. Triple-crown burner (TC)
2. Semi-rapid back burner (SR)
3. DUAL burner (DUAL)
4. Auxiliary burner(A)

## **90cm hob with front commands**

### **Mod: P9(\*\*)*F16 (Fig.11)***

1. Auxiliary burner (A)
2. Rapid burner ( R )
3. Semi-rapid back burner (SR)
4. Semi-rapid front burner (SR)
5. Triple-crown burner (TC)

### **Mod: P9(\*\*)*F-N (fig. 12)***

1. Auxiliary burner (A)
2. Rapid left back burner ( R )
3. Semi-rapid back burner (SR)
4. Semi-rapid right front burner (SR)
5. Semi-rapid central front burner (SR)
6. Rapid central back burner ( R )

### **Mod: P9(\*\*)*F20 (Fig. 13)***

1. DUAL burner (DUAL)
2. Semi-rapid back burner (SR)
3. Rapid burner ( R )
4. Semi-rapid front burner (SR)
5. liary burner (A)

### **Mod: P9(\*\*)*F-T (Fig. 14)***

1. Triple-crown burner (TC)
2. Auxiliary burner (A)
3. Semi-rapid back burner (SR)
4. Semi-rapid front burner (SR)

### **Mod: P9(\*\*)*F22 (Fig. 15)***

1. Triple-crown burner (TC)
2. BruciaAuxiliary burner(A)
3. Semi-rapid back burner (SR)
4. Semi-rapid front burner (SR)
5. Fish Kettle burner (P)

### **Mod: P9(\*\*)*F13 (Fig. 16)***

1. Triple-crown burner (TC)
2. Semi-rapid burner (SR)
3. BruciatoAuxiliary burner(A)

### **Mod: P9(\*\*)*F24 (Fig. 17)***

1. Triple-crown burner (TC)
2. Auxiliary burner (A)
3. DUAL burner (DUAL)

### **Mod: P9(\*\*)*F26 (Fig. 18)***

1. Triple-crown burner (TC)
2. Electric plate ø 145
3. DUAL burner (DUAL)

### **Mod: P9(\*\*)*F25 (Fig. 19)***

1. Triple-crown burner (TC)
2. Fish Kettle burner (P)
3. DUAL burner (DUAL)

## **90cm hob with side commands**

### **Mod: P9(\*\*)L-5 (Fig.20)**

1. Auxiliary burner (A)
2. Rapid burner ( R )
3. Semi-rapid left back burner (SR)
4. Semi-rapid right front burner (SR)
5. Triple-crown burner (TC)

### **Mod: P9(\*\*)L28 (Fig.21)**

1. Auxiliary burner (A)
2. Rapid burner ( R )
3. Semi-rapid left back burner (SR)
4. Semi-rapid right front burner (SR)
5. Triple-crown burner (TC)
6. Electric plate ø 145

### **Mod: P9(\*\*)L-B (Fig.22)**

1. Auxiliary burner (A)
2. Fish Kettle burner (P)
3. Semi-rapid left back burner (SR)
4. Semi-rapid right front burner (SR)
5. Triple-crown burner (TC)

### **Mod: P9(\*\*)L23 (Fig.23)**

1. Auxiliary burner (A)
2. Fish Kettle burner (P)
3. Semi-rapid left back burner (SR)
4. Semi-rapid right front burner (SR)
5. DUAL burner (DUAL)

### **Mod: P9(\*\*)L-C (Fig.24)**

1. Auxiliary burner (A)
2. Electric plate ø 180
3. Semi-rapid left back burner (SR)
4. Semi-rapid right front burner (SR)
5. Rapid burner ( R )
6. Electric plate ø 145

### **Mod: P9(\*\*)L-7 (Fig.25)**



1. Auxiliary burner (A)
2. Electric plate ø 145
3. Semi-rapid left back burner (SR)
4. Semi-rapid right front burner (SR)
5. Rapid burner ( R )

### **Mod: P9(\*\*)L27 (Fig.26)**

1. Auxiliary burner (A)
2. Electric plate ø 180
3. Semi-rapid left back burner (SR)
4. Semi-rapid right front burner (SR)
5. Rapid burner ( R )

### Gas burners

The flow of gas to the burners is regulated by the knobs shown in 30 which command the valves. Depending on the chosen version, the symbols can be printed onto the knobs or the command panel. The following regulations are obtained when the indicator points to the printed symbols:

- Valve closed, no gas flow
-  Maximum capacity, maximum gas flow
-  Minimum capacity, minimum gas flow

### Switching on the burners

#### **- Burners without safety valves**

To turn on burners without electric ignition, or when there is no electrical power in models with ignition, place a flame near to the upper part of the burner, press and turn the knob anti-clockwise so that it points to the  symbol with the reference on the panel.

Turn the knob to the small flame for minimum capacity.

**All working positions must be chosen between the maximum and minimum and never the maximum and switch-off point.**



To turn the burner off, turn the knob clockwise until it reaches position "valve closed"

#### **- Burners with electric ignition**

##### ➤ **Models with ignition button**

To switch on one of the burners, press the ignition button and turn the knob to the maximum flow button (symbol ). Hold the ignition button down until it lights and then adjust the flame by turning the knob until the desired flame is obtained.

##### ➤ **Models with ignition incorporated into the knob**

These models are identified with the  symbol near to the  symbol (maximum flow).

To light one or more burners, press and turn the knob to maximum flow and hold it down until the burners are lit; turn the knob until the desired flame is obtained.

#### **Note:**

If it is difficult to light the burner with the knob in the maximum position because of local gas flow, we recommend repeating the operation with the knob on minimum before placing a vessel on the ring.

#### **- Burners with safety valves**

Some models have safety valves which automatically interrupts gas flow should the burner switch itself off for any reason.

Turn the knob to the  and repeat the lighting operations explained in the following paragraphs to restore functionality.

##### ➤ **Using the burner**

According to the type of electric ignition, proceed as follows:

-  For models with ignition incorporated in the knob, turn the gas valve knob to maximum flow and then press and hold it down for about 4 to 5 seconds. Release the knob and adjust the flame by turning the knob until it reaches the desired intensity.

**Warning:**

**The ignition device cannot be activated for more than 15 seconds.**

**If it still has not lit after this time or it turned off accidentally, wait for 1 minute before repeating the operation.**

- For models with ignition button, turn the gas valve knob to maximum flow and then press the ignition button and hold it down for about 4 to 5 seconds. Release the knob and adjust the flame by turning the knob until it reaches the desired intensity.

### Using the ring

Hob grids were designed to make the product easy and safe to use. We recommend checking their exact position and stability on the hob before each use. Furthermore, check that the supporting rubbers are integral and correctly positioned.

### Gird for small vessels (Fig. 27)

Only use the auxiliary burner ring (the smallest) for vessels with a small diameter to prevent them from tipping.

### Special ring for WOKs (Fig. 28 optional)

Only use the triple crown ring for WOKs (concave bases). In order to avoid serious burner malfunction, we recommend **not using woks without this special ring and not to use it for flat-based pans**

### Choosing the burner

The symbology printed on the panel (diagram fig. 29) to the side of the knob indicated the correspondence between the knob and the burner. Choosing the most adapted burner depends on the vessels' diameter and capacity (see table).

It is important that the pan's diameter is adequate to the burner power not to compromise high yield.

<b>Burner</b>	<b>Pan diameter</b>	
	<b>Minimum diameter</b>	<b>Maximum diameter</b>
Auxiliary	60 mm <i>(with reduction)</i>	140 mm
Semi-rapid	160 mm	200 mm
Rapid	200 mm	240 mm
Triple crown	240 mm	260 mm
Dual	240 mm	260 mm
Fish pan	Maximum dimensions: 140X350 mm	

### Electric plates

**Never cook food directly on electric plates but in proper pans or vessels**

### Switching on the plate

The electric plate is switched on by turning the knob to the position desired.

Depending on whether the hob has a switch or energy regulator numbers 1 to 6 or from 1 to 11 (fig. 30) indicate the functioning positions with increasing temperatures (see table).

A light on the control panel is lit when the electric plate is working.



### Using the electric plate

Once boiling point is reached, adjust the power based on heating intensity desired, bearing in mind that the plate will continue to emit heat for some minutes after being turned off.

When using the electric plate it is important to remember:

- ☞ **It is crucial not to use it without vessels.** If the plate is used with nothing on it, it can cause fires, especially if used like this for some time.
- ☞ Do not pour liquids on the plates when they are hot.
- ☞ Only use flat-based pans with a diameter that covers the whole surface of the plate.

<i>Knob position</i>		<b><i>Type of Cooking</i></b>
0	0	Off
1	1	For melting (butter or chocolate)
2	2	
2	2	For keeping food hot and heating small amounts of food
	3	
	4	
3	4	Heating larger quantities, whipping cream and sauces
	5	
	6	
4	7	Slow boiling, for soup, pasta, risotto, continuation steam cooking, steak and general frying
	8	
4	8	Reddening meat, roast potatoes, fried fish and for boiling large amounts of water
5	9	
5	10	
6	11	Fast frying, grilled steak etc.
	12	

### Plate type

The hob can have a normal or fast plate. The normal plate is completely black whereas the fast one has a red centre. Consult section “**Characteristics of the plate – Cooking Point**” for technical characteristics.

The fast plate differs from the normal one basically because:

- ☞ It has higher power.
- ☞ It reaches the desired temperature more rapidly.

### Glass-ceramic hob.

The glass-ceramic hob has the feature of allowing rapid heat transmission vertically from the heating elements located under the surface to the pans placed upon it.

The heat is not propagated horizontally so the glass remains “cold” up to just a few centimetres from the cooking area.

The cooking areas are commanded by a 7-position switch or by a continuous eleven position energy regulator as shown in figure 30.

Heating intensity in these areas is adjusted increasing from “0” (off) to “6” or “11” (max).

When the hob is operational, the signalling light is lit.

When the temperature in the cooking zone is higher than 70°C the corresponding “remaining heat” light goes on, indicating that the area is hot.

This light remains on after the cooking zone is turned off to signal that the zone is still hot.

Remaining heat continues some time after the cooking zone is switched off.

**During this time the cooking area must not be touched; most of all, pay attention to children.**

The light automatically switches off when the temperature in this area lowers to under 70°C.

### **Advice for using the hob safely**

- ☞ Before switching on, identify which knob controls the desired cooking area.
- ☞ We recommend placing the vessel on the cooking zone before switching on and to remove it after turning off.
- ☞ Use vessels with even, flat bases mind cast-iron vessels. Uneven bases can scratch the surface of the glass-ceramic. Make sure that the base is clean and dry.
- ☞ Do not use the hob if the surface is broken or damaged.
- ☞ Remember that the cooking area remains hot for some time (about 30 minutes) after switch-off.
- ☞ Do not let heavy or sharp objects drop onto the glass-ceramic.
- ☞ As soon as you notice a crack on the hob, remove the power supply and call the Assistance Centre.
- ☞ Do not point intense halogen lamps onto the hob.
- ☞ Never cook food directly on the glass-ceramic hob, but in proper cooking vessels.

### **Types of cooking areas**

#### **“3” circuit radiating area**

The heating element is made up of 3 electric resistances which can work together or separately depending on the seven-position switch or the 0-11 energy regulator.

#### **“Hi-light” radiating zone**

The heating element is made up of a coiled band resistance which reaches working temperature very quickly. A continuous energy regulator commands this working area.

#### **Halogen zone**

The heating element is made up of 2 halogen lamps and an electric resistance. It instantaneously reaches the working temperature. This is also controlled by a continuous energy regulator.

## **INSTALLATION INSTRUCTIONS**

### **Important!**

The instructions are for a qualified installer.

The appliance must be installed correctly, conforming to the laws in force.

***Remove the electrical power supply before intervening on the appliance.***

### **Installation on the top (furniture plane)**

The cooking hob can be installed on fittings as long as they are heat-resistant (minimum temperature 90°C) The size of the hole to be drilled into the furniture plane and the minimum distance between the back, side and overhead upper walls are shown in figures 31,32, 33, 34,35 and 36.

Note that:

- ☞ When the hob is installed without the oven in pair a separation panel is obligatory between the hob base and the furniture underneath at a distance of at least 10 mm.
- ☞ When the hob/oven are a pair, interpose a divider at a minimum distance of 15mm and following the oven supplier's instructions maintaining aeration as specified in fig.41. ***In any case, electrical connection of the two apparati must be carried out separately***, both for electrical reasons and to facilitate extraction.

***We recommend the use of an oven equipped with forced internal cooling.***

### **Fixing the hob**

The hob is to be fixed to the furniture as follows:

- ☞ Place the sealing gasket supplied along the outside edge of the hole drilled in the fittings following the scheme indicated in fig. 37 so that the ends of the strips are perfectly joined without overlapping.
- ☞ Position the hob into the hole in the fittings making sure it is centered.
- ☞ Attach the hob to the fittings with the supplied mounts as shown in fig. 38.

When the sealing gasket is correctly installed, it is an absolute guarantee against infiltration of liquids.

### **Place of installation and discharge of combustion products.**

- ☞ **The appliance must be installed and operational in the best possible location and in any case according to the laws in force.**

**The installer must refer to the laws in force concerning ventilation and evacuation of combustion products.**

**We would remind you that the air necessary for combustion is 2m<sup>3</sup>/h for every kW of power (gas) installed.**

### **Place of installation**

The place where the gas appliance is installed requires a natural air flow necessary for gas combustion (norms UNI-CIG 7129 e 7131)

The air flow must come directly from one or more openings made on a free area of at least 100 cm<sup>2</sup> (A). If the appliance does not have a safety valve, this opening should have a minimum area of at least 200 cm<sup>2</sup> (fig. 40). The opening should be built so that it will not be blocked internally or externally and it is near to the floor, preferably on the opposite side from the evacuation of combustion products.

If the required openings cannot be made, the necessary air can come from an adjacent room which is ventilated as required as long as this room is not a bedroom, a dangerous area or under vacuum (UNI-CIG 7129).

### ***Discharging combustion products***

As appliances must discharge combustion products through ventilation hoods directly connected to the chimney flue or to the outside (fig. 40).

If a hood cannot be installed, an electro-ventilator must be used which is applied to an external wall or to the window in the room.

The electro-ventilator must have a capacity which ensures that the air in the kitchen is exchanged at least 3 to 5 times its volume (UNI-CIG 7129).

*Components illustrated in fig. 40*

- A:** Opening for air entry
- C:** hood for evacuating combustion products
- E:** Electro-ventilator for evacuating combustion products.

### **Connection to the gas plant**

- ☞ **Before installation, make sure that the local distribution conditions (gas nature and pressure) and the hob adjustments are compatible. To do this, check the data on the product plate on the hob and on this booklet.**

Gas connection must be carried out in conformity with norms UNI-CIG 7129 e 7131. The hob must be connected to the gas plant using rigid metallic pipes or continuous wall flexible stainless steel pipes which conform to norm UNI-CIG 9891 with a maximum extension of 2 m.

Make sure that when using flexible pipes, these do not come into contact with moving or flattened parts.

Carry out the connection so that the appliance is not subjected to stress in any way.

The incoming gas connection pipe is threaded G½".

No sealing is necessary for ISO R7 connections.

The supplied head washer is to be interposed with ISO R228 connections.

☞ **After connection, check that the connections hold using a soapy solution.**

### **Connection to the mains**

The apparatus must be connected to the mains checking that the voltage matches the value shown on the characteristics plate and that the plant cable section can sustain the load also indicated on the plate.

Should the appliance be directly connected to the mains, an omni-polar switch, with a minimum opening of 3mm between contacts, of the right size for the load and responding to the pertinent norms has to be interposed between the appliance and the mains.

☞ **Do not use reducers, adapters or deviators for mains connection as they could overheat and burn.**

☞ **Earthing the appliance is obligatory. The manufacturer will not be responsible for the non-observance of this norm.**

If the power supply cable is to be substituted, use a cable with the same characteristics as that supplied, adapted to load and temperature (**type T90°C**) it must be requested from assistance. It is also necessary that the end on the appliance side has a Yellow-Green earth wire 20mm longer than the others.

Consult the table below for the power supply cable dimensions

<i>Hob type</i>	<i>Dimensions</i>
<i>Only with gas burners</i>	<i>3X0,50 mm<sup>2</sup></i>
<i>With one 1000W electric plate</i>	<i>3 X 0,75 mm<sup>2</sup></i>
<i>With one 1500W electric plate and two electric plates</i>	<i>3 X 1,5 mm<sup>2</sup></i>

## **ADAPTATION TO DIFFERENT TYPES OF GAS**

Should the hob need to be adapted to a gas different to the one it was intended for, the injectors have to be replaced.

If there are no spare injectors supplied they can be obtained from Assistance.

The injectors are to be chosen according to the injector table.

Injectors can be identified by diameter expressed in hundredths of mm printed on the injector itself.

### **Replacing the injectors**

- ❖ Remove the gas rings and burner caps from the hob.
- ❖ Using a face spanner, replace injectors "J" (fig. 42) with those ideal for the gas to be used.
- ❖ Remount the burners.

**The burners do not require primary air regulation**

### **Regulating the minimum**

Having replaced the injectors, switch on the burner and remove the knob. Place the valve on minimum, insert a screw into the rod: screw to decrease the flame, unscrew to increase it (fig. 42)

### **Completely screw the adjuster screw for G30/G31 gas**

In any case the result should be a small homogeneous flame which is even all around the burner crown.

Finally, check that the flame does not go off when rapidly turning the valve from maximum to minimum. With safety burners, check that the flame slightly brushes the thermoelectric couple. Check correct regulation by leaving the burner on for a few minutes. If it goes off, increase the minimum.

## **CLEANING**

*To preserve the hob well it needs to be cleaned regularly after every use, when it has cooled down.*

***Never remove the knobs from their housing***

### **Enamel parts**

All enamel parts should only be washed with a sponge and soapy water or other specifically non-abrasive products. Dry completely.

### **Steel plane**

The stainless steel plane should be cleaned with a damp cloth and specific products that are found in shops. After rinsing, dry with a chamois leather if possible.

### **Gas rings**

The hob's enamel gas rings were designed to be washed also in dishwashers. Stainless steel rings can turn blueish in the burner area because of the heat. Common sponges for steel can be used to decrease this effect.

### **Burners**

The burners are made up of two pieces and can be removed and cleaned with suitable products. After cleaning they must be completely dry and replaced exactly into their housings.

Models with electrical ignition: make sure that electrode "E" (fig. 44) is always clean.

Models with safety devices: clean probe "T" (fig. 44) so that the safety valve works properly. The electrode and the probe must be cleaned carefully.

Afterwards, replace the burners precisely into their housings.

*To avoid damaging the electric ignition, avoid using it when the burners are not in place.*

### **Electric plates**

The electric plates should be cleaned when they are still warm.

Clean with a damp cloth and finish off with a cloth dipped in mineral oil.

The apparati do not need particular maintenance, all the same we recommend a full check at least once every two years.

Should the knob rotation become hard or there is a smell of gas, close the general valve and call technical assistance.

The faulty valve should be replaced together with its gasket.

<b><u>Cat.: II 2H 3+</u></b>		<b><u>IT GB ES PT CH IE</u></b>		
Tipo di gas/ gas type/ type de gaz/ tipo de gas/ tipo de gás/ gaz type				<b>G20</b>
Pressione del gas/ gas pressure/ pression gaz/ presion gas/ pressão gas				<b>20 mbar</b>
Bruciatori/ burners/ bruleurs/ quemodores/ bocas de gás/ branders	Portata/power inputs/débit gas/capacidad/vazão /debit Max (kW)	Portata/power inputs/débit gas/capacidad/vazão /debit Min (kW)	Ø Iniettore/injectors/injecteur/ inyector/injector/sproeier	
A	1.00	0.30	0.72	
SR	1.75	0.44	0.97	
R	3.00	0.75	1.15	
TC	3.30	1.50	1.24	
TC	3.80	1.50	1.35	
P/F	2.90	1.50	1.20	
TC 4,5	4.30	0.30	In	out
			0.66	1.00
Tipo di gas/ gas type/ type de gaz/ tipo de gas/ tipo de gás/ gaz type				<b>G30/G31</b>
Pressione del gas/ gas pressure/ pression gaz/ presion gas/ pressão gas				<b>28-30/37 mbar</b>
Bruciatori/ burners/ bruleurs/ quemodores/ bocas de gás/ branders	Portata/power inputs/débit gas/capacidad/vazão /debit Max (kW)	Portata/power inputs/débit gas/capacidad/vazão /debit Min (kW)	Ø Iniettore/injectors/injecteur/ inyector/injector/sproeier	
A	1.00	0.30	0.50	
SR	1.75	0.44	0.65	
R	3.00	0.75	0.85	
TC	3.30	1.50	0.91	
TC	3.80	1.50	0.98	
P/F	2.90	1.50	0.85	
TC 4,5	4.30	0.30	In	out
			0.46	0.64

**Fig. 1**

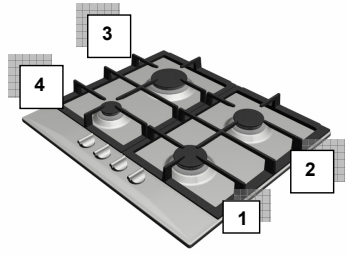

**Fig. 2**

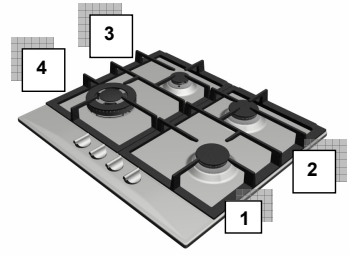

**Fig. 3**

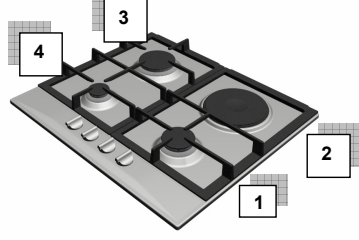

**Fig. 4**

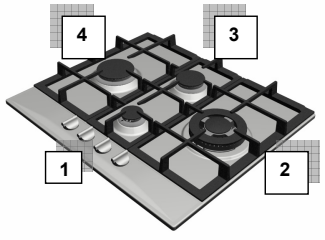

**Fig. 5**

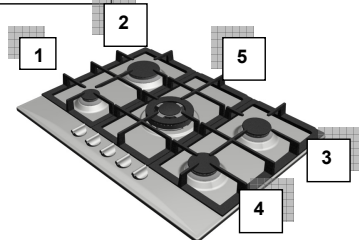

**Fig. 6**

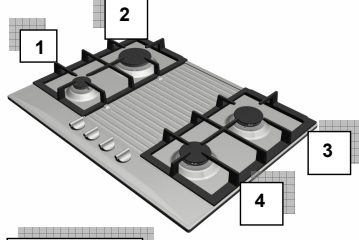

**Fig. 7**

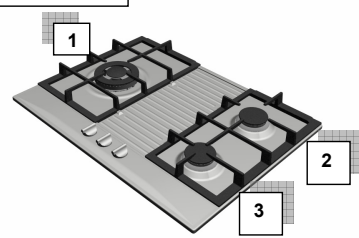

**Fig. 8**

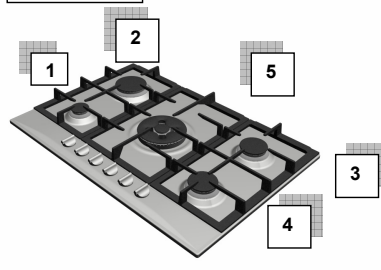

Fig. 9

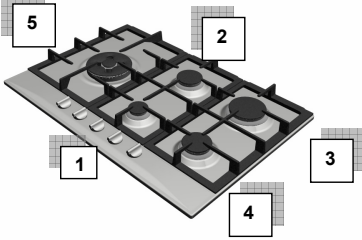

Fig. 10

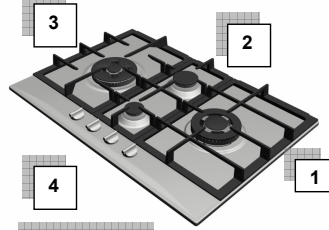

Fig. 11

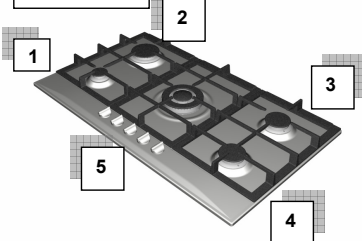

Fig. 12

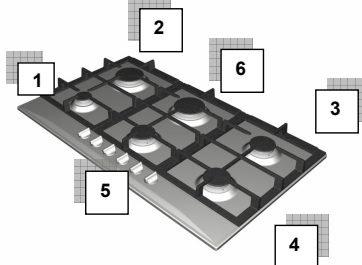

Fig. 13

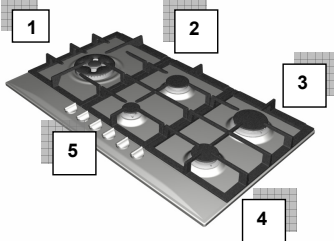

Fig. 14

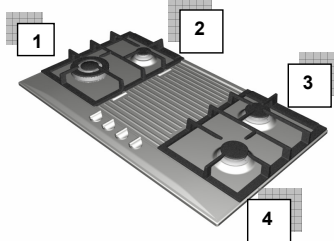

Fig. 15

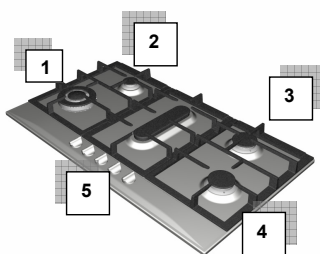
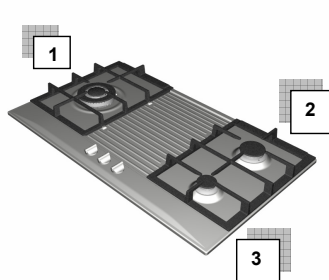
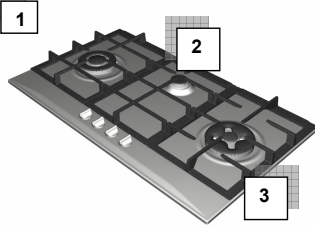

Fig. 16

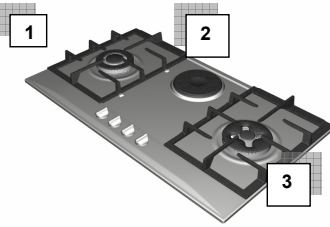



**Fig. 17**



**Fig. 18**



**Fig. 19**

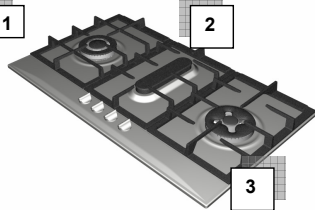

Fig. 20

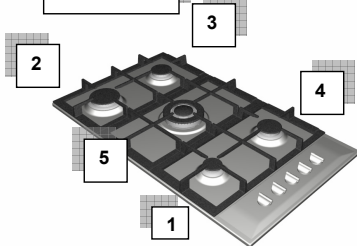

Fig. 21

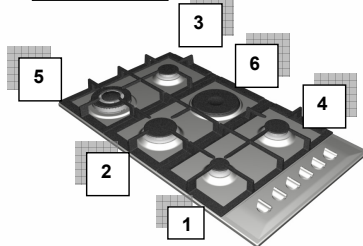

Fig. 22

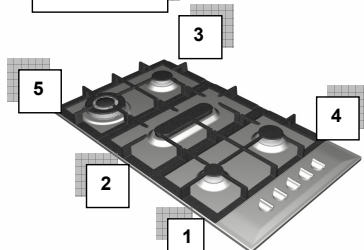

Fig. 23

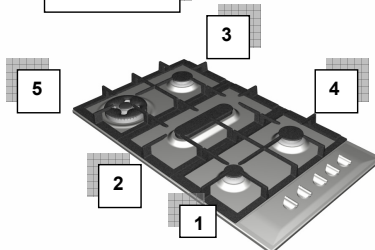

Fig. 24

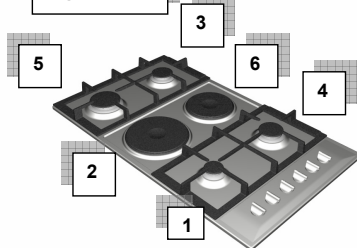

Fig. 25

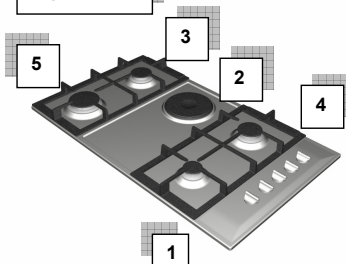
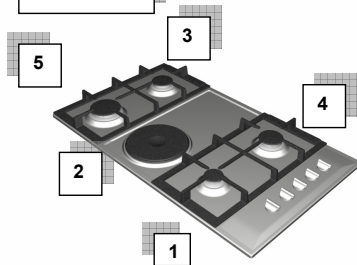
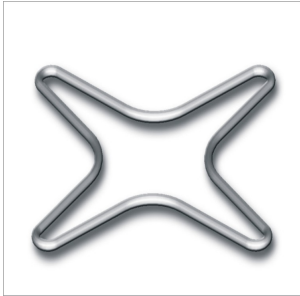

Fig. 26



**Fig. 27**



**Fig. 28**



**Fig. 29**

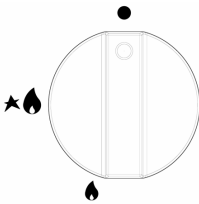

**Fig. 30**

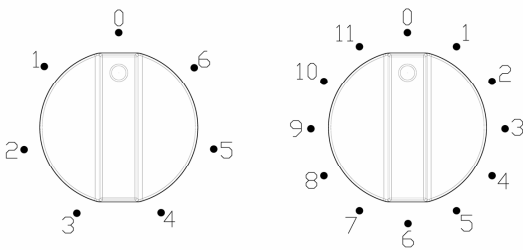

**Fig. 31**

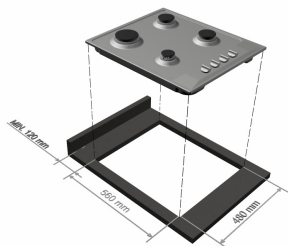

**Fig. 32**

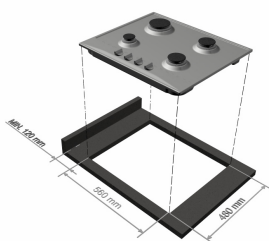

**Fig. 33**

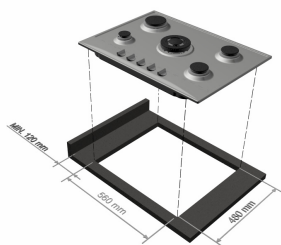

**Fig. 34**

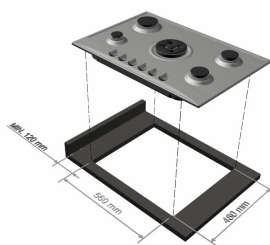

**Fig. 35**

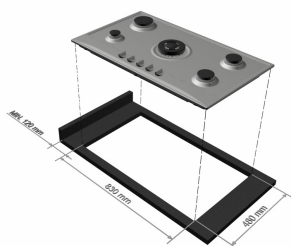

**Fig. 36**

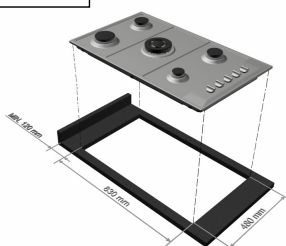

**Fig. 37**

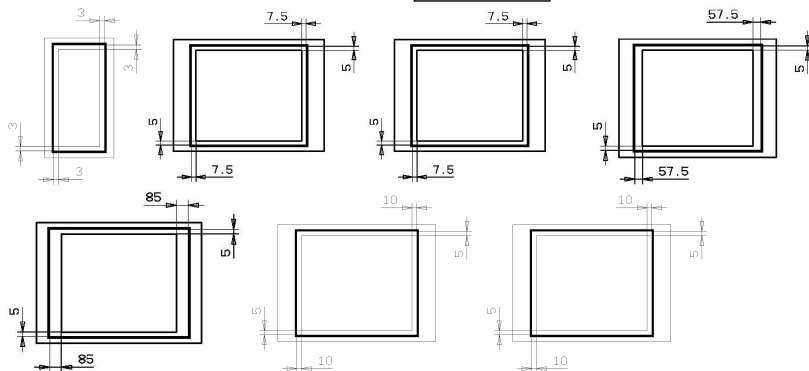

**Fig. 38**

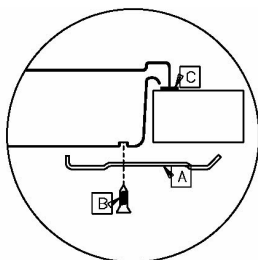

**Fig. 39**

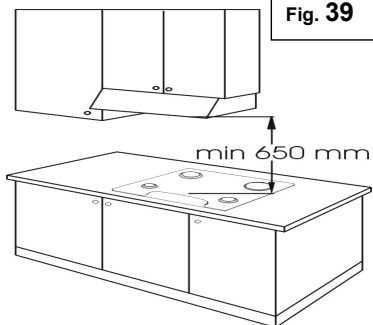

E

C

A

**Fig. 40**

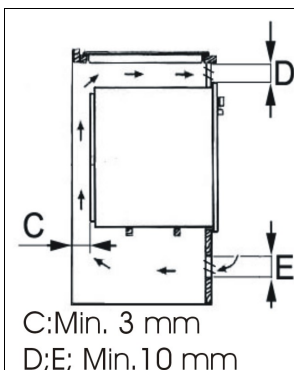

C: Min. 3 mm

D; E: Min. 10 mm

**Fig. 41**

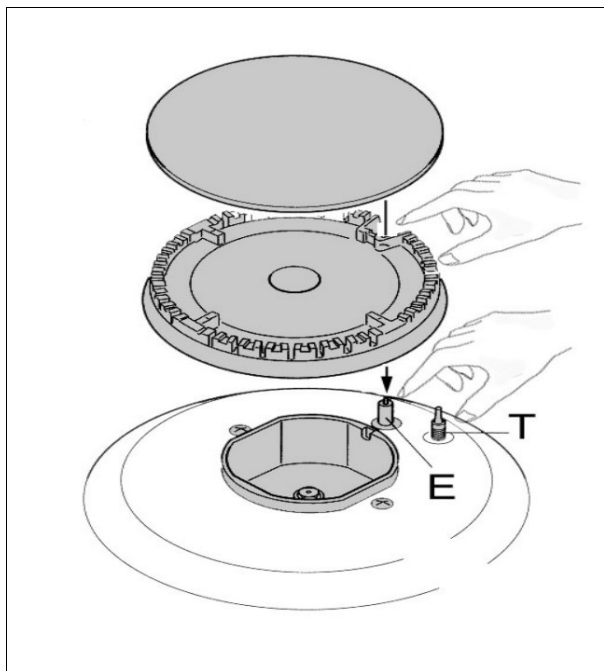
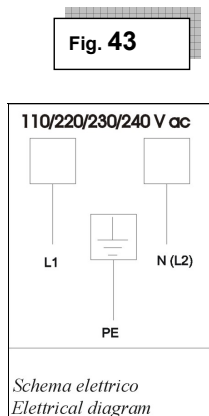
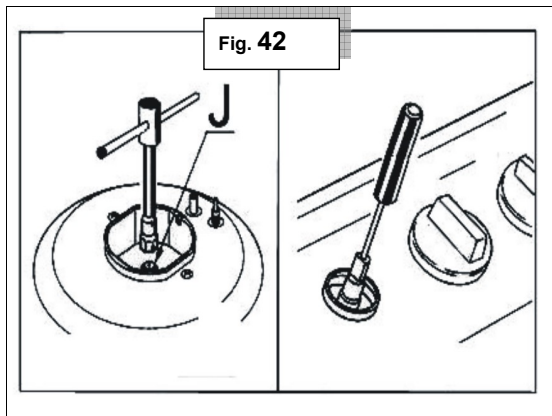

**Fig. 44**

**D** In Übereinstimmung mit den Anforderungen der Europäischen Richtlinie 2002/96/EG über Elektro- und Elektronik-Altgeräte (WEEE) ist vorliegendes Gerät mit einer Markierung versehen. Sie leisten einen positiven Beitrag für den Schutz der Umwelt und die Gesundheit des Menschen, wenn Sie dieses Gerät einer gesonderten Abfallsammlung zuführen. Im unsortierten Siedlungsmüll könnte ein solches Gerät durch unsachgemäße Entsorgung negative Konsequenzen nach sich ziehen.

Auf dem Produkt oder der beiliegenden Produktdokumentation ist

folgendes Symbol  einer durchgestrichenen Abfalltonne abgebildet. Es weist darauf hin, dass eine Entsorgung im normalen Haushaltsabfall nicht zulässig ist. Entsorgen Sie dieses Produkt im Recyclinghof mit einer getrennten Sammlung für Elektro- und Elektronikgeräte.

Die Entsorgung muss gemäß den örtlichen Bestimmungen zur Abfallbeseitigung erfolgen.

Bitte wenden Sie sich an die zuständigen Behörden Ihrer Gemeindeverwaltung, an den lokalen Recyclinghof für Haushaltsmüll oder an den Händler, bei dem Sie dieses Gerät erworben haben, um weitere Informationen über Behandlung, Verwertung und Wiederverwendung dieses Produkts zu erhalten.

**GB** This appliance is marked according to the European directive 2002/96/EC on Waste Electrical and Electronic Equipment (WEEE). By ensuring this product is disposed of correctly, you will help prevent potential negative consequences for the environment and human health, which could otherwise be caused by inappropriate waste handling of this product.

The symbol  on the product, or on the documents accompanying the product, indicates that this appliance may not be treated as household waste. Instead it shall be handed over to the applicable collection point for the recycling of electrical and electronic equipment.

Disposal must be carried out in accordance with local environmental regulations for waste disposal.

For more detailed information about treatment, recovery and recycling of this product, please contact your local city office, your household waste disposal service or the shop where you purchased the product.

**F** Cet appareil porte le symbole du recyclage conformément à la Directive Européenne 2002/96/CE concernant les Déchets d'Équipements Électriques et Électroniques (DEEE ou WEEE). En procédant correctement à la mise au rebut de cet appareil, vous contribuerez à empêcher toute conséquence nuisible pour l'environnement et la santé de l'homme.

Le symbole  présent sur l'appareil ou sur la documentation qui l'accompagne indique que ce produit ne peut en aucun cas être traité comme déchet ménager. Il doit par conséquent être remis à un centre de collecte des déchets chargé du recyclage des équipements électriques et électroniques.

Pour la mise au rebut, respectez les normes relatives à l'élimination des déchets en vigueur dans le pays d'installation.

Pour obtenir de plus amples détails au sujet du traitement, de la récupération et du recyclage de cet appareil, veuillez vous adresser au bureau compétent de votre commune, à la société de collecte des déchets ou directement à votre revendeur.

**NL** Dit apparaat is voorzien van het merkteken volgens de Europese richtlijn 2002/96/EG inzake Algeenname elektronische apparaten (AEEA).

Door ervoor te zorgen dat dit product op de juiste manier als afval wordt verwerkt, helpt u mogelijk negatieve consequenties voor het milieu en de menselijke gezondheid te voorkomen die anders zouden kunnen worden veroorzaakt door onjuiste verwerking van dit product als afval.

Het symbool  op het product of op de bijbehorende documentatie geeft aan dat dit product niet als huishoudelijk afval mag worden behandeld. In plaats daarvan moet het worden afgegeven bij een verzamelpunt voor recycling van elektrische en elektronische apparaten.

Afdanking moet worden uitgevoerd in overeenstemming met de plaatselijke milieuvorschriften voor afvalverwerking.

Voor nadere informatie over de behandeling, terugwinning en recycling van dit product wordt u verzocht contact op te nemen met het stadskantoor in uw woonplaats, uw afvalophaldienst of de winkel waar u het product heeft aangeschaft.

**E** Este aparato lleva el marcado CE en conformidad con la Directiva 2002/96/EC del Parlamento Europeo y del Consejo sobre residuos de aparatos eléctricos y electrónicos (RAEE). La correcta eliminación de este producto evita consecuencias negativas para el medioambiente y la salud.

El símbolo  en el producto o en los documentos que se incluyen con el producto, indica que no se puede tratar como residuo doméstico. Es necesario entregarlo en un punto de recogida para reciclar aparatos eléctricos y electrónicos.

Deséchelo con arreglo a las normas medioambientales para eliminación de residuos. Para obtener información más detallada sobre el tratamiento, recuperación y reciclaje de este producto, póngase en contacto con el ayuntamiento, con el servicio de eliminación de residuos urbanos o la tienda donde adquirió el producto.

**P** Este aparelho está classificado de acordo com a Directiva Europeia 2002/96/EC sobre Resíduos de equipamento eléctrico e electrónico (REEE).

Ao garantir a eliminação adequada deste produto, estará a ajudar a evitar potenciais consequências negativas para o ambiente e para a saúde pública, que poderiam derivar de um manuseamento de desperdícios inadequado deste produto.

O símbolo  no produto, ou nos documentos que acompanham o produto, indica que este aparelho não pode receber um tratamento semelhante ao de um desperdício doméstico.

Pelo contrário, deverá ser depositado no respectivo centro de recolha para a reciclagem de equipamento eléctrico e electrónico. A eliminação deverá ser efectuada em conformidade com as normas ambientais locais para a eliminação de desperdícios.

Para obter informações mais detalhadas sobre o tratamento, a recuperação e a reciclagem deste produto, contacte o Departamento na sua localidade, o seu serviço de eliminação de desperdícios domésticos ou a loja onde adquiriu o produto.

**I** Questo apparecchio è contrassegnato in conformità alla Direttiva Europea 2002/96/EC, Waste Electrical and Electronic Equipment (WEEE). Assicurandosi che questo prodotto sia smaltito in modo corretto, l'utente contribuisce a prevenire le potenziali conseguenze negative per l'ambiente e la salute.

Il simbolo  sul prodotto o sulla documentazione di accompagnamento indica che questo prodotto non deve essere trattato come rifiuto domestico ma deve essere consegnato presso l'adeguato punto di raccolta per il riciclaggio di apparecchiature elettriche ed elettroniche.

Disfarsene seguendo le normative locali per lo smaltimento dei rifiuti. Per ulteriori informazioni sul trattamento, recupero e riciclaggio di questo prodotto, contattare l'ufficio locale, il servizio di raccolta dei rifiuti domestici o il negozio presso il quale il prodotto è stato acquistato.

**GR** Αυτή η συσκευή φέρει σήμανση σύμφωνα με την Ευρωπαϊκή οδηγία 2002/96/ΕΕ σχετικά με Απορριπτόμενα Ηλεκτρικά και Ηλεκτρονικά εξαρτήματα (WEEE). Εξοφελίζοντας ότι το προϊόν αυτό απορριπτείται ουσιά, θα βοηθήσετε στην πρόληψη πιθανών αρνητικών επιπτώσεων για το περιβάλλον και την ανθρώπινη υγεία, οι οποίες θα μπορούσαν να δημιουργηθούν από τον ακατάλληλο χειρισμό αυτού του προϊόντος ως απόρριμμα.

Το σύμβολο  πάνω στο προϊόν, ή στο έγγραφο που συνοδεύουν το προϊόν, υποδεικνύει ότι αυτή η συσκευή δεν μπορεί να θεωρηθεί οικιακό απόρριμμα. Αντί γι αυτό θα πρέπει να παραδοθεί στο κατάλληλο σημείο περισυλλογής για την ανακύκλωση των ηλεκτρικών και ηλεκτρονικών εξαρτημάτων.

Διαβάστε το προϊόν της τοπικής νομοθεσία για τη διάθεση των απορριμμάτων. Για πιο λεπτομερείς πληροφορίες σχετικά με την επεξεργασία, την περιποίηση και την ανακύκλωση αυτού του προϊόντος, παρακαλούμε επικοινωνήστε με το αρμόδιο γραφείο της τοπικής σας αυτοδιοίκησης. Την τοπική σας υπηρεσία αποκομιδής οικιακών απορριμμάτων ή το κατάστημα όπου αγοράσατε αυτό το προϊόν.

**S** Denna produkt är märkt enligt EG-direktiv 2002/96/EC beträffande elektrisk och elektronisk avfall (Waste Electrical and Electronic Equipment, WEEE).

Genom att säkerställa en korrekt kassering av denna produkt bidrar du till att förhindra potentiella, negativa konsekvenser för vår miljö och vår hälsa, som annars kan bli följden om produkten inte hanteras på rätt sätt.

Symbolen  på produkten, eller i medföljande dokumentation, indikerar att denna produkt inte får behandlas som vanligt hushållsavfall. Den skall i stället lämnas in på en lämplig uppsamlingsplats för återvinning av elektrisk och elektronisk utrustning.

Produkten måste kasseras enligt lokala miljöbestämmelser för avfallshantering.

För mer information om hantering, återvinning och återanvändning av denna produkt, var god kontakta de lokala myndigheterna, ortens sophanteringsstjänst eller butiken där produkten inhandlades.

**N** Dette apparat er merket i samsvar med EU-direktiv 2002/96/EC om avhending av elektrisk og elektronisk utstyr (Waste Electrical and Electronic Equipment - WEEE). Forsikr deg om at dette produktet blir avhendet på korrekt vis, slik at det ikke kan utgjøre noen helse- eller miljørisiko.

Symbol  på produktet eller på dokumentene som følger med det, viser at dette produktet ikke må behandles som husholdningsavfall. Lever det til et autorisert mottak for resirkulering av elektrisk og elektronisk utstyr.

Avhending må skje iht. de lokale renovasjonsforskriftene. For nærmere informasjon om håndtering, kassering og resirkulering av dette produktet, kontakt kommunen, renovasjonsvesenet eller forretningen der du anskaffet den.

**DK** Dette produkt er merket i henhold til EU-direktiv 2002/96/EF om Kasseret elektrisk og elektronisk utstyr (WEEE). Ved å sikre, at dette produktet bliver skrottet korrekt, hjælper man med til at forhindre potentielle, negative konsekvenser for miljøet og folkesundheden, der kunne opstå gennem u hensigtsmæssig bortskaffelse af dette produkt.

Symbol  på produktet eller på dokumenterne, der ledsager produktet, angiver, at produktet ikke må bortskaffes sammen med husholdningsaffaldet. Det skal i stedet afleveres på en genbrugsstation for elektrisk og elektronisk udstyr. Det skal skrotes i henhold til gældende lokale miljøregler for bortskaffelse af affald.

For yderligere oplysninger om håndtering, genvinding og genbrug af dette produkt bedes man kontakte de lokale myndigheder, renovationselskabet eller forretningen, hvor produktet er købt.

**FIN** Tämä laite on merkitty WEEE-direktiivin (Waste Electrical and Electronic Equipment) 2002/96/EC mukaisesti. Varmistamalla, että tuote poistetaan käytöstä asianmukaisesti, voidaan auttaa estämään sellaiset ympäristö- ja terveyshaitat, jotka saattaisivat aiheutua jätteiden asiattomasta käsittelystä.

Symboli  tuoteesta tai sen dokumentaatiosta tarkoittaa, ettei laitetta saa hävittää kotitalousjätteen mukana. Sen sijaan tuote on toimitettava sähkö- ja elektronikkokomponenttien keräys- ja kierrätyspisteeseen.

Laitteen käytöstäpoiston suhteen on noudatettava paikallisia jätteenhuoltomääräyksiä. Lisätietoja tuotteen käsittelystä, talteenotosta ja kierrätyksestä saa kaupunki- tai kunnanturvastosta, paikallisesta jätteenhuoltoilikeestä tai liikkeestä, josta tuote ostettiin.

**PL** Niniejsze urządzenie posiada oznaczenia zgodnie z Dyrektywą Europejską 2002/96/EC w sprawie zużytego sprzętu elektrycznego i elektronicznego (WEEE). Zapewniając prawidłowe złomowanie niniejszego urządzenia przyczynią się Państwo do ograniczenia ryzyka wystąpienia negatywnego wpływu produktu na środowisko i zdrowie ludzi, które mogłoby zaistnieć w przypadku niewłaściwej utylizacji urządzenia.

Symbol  umieszczony na produkcie lub na dołączonych do niego dokumentach oznacza, że niniejszy produkt nie jest klasyfikowany jako odpad z gospodarstwa domowego.

Urządzenie, w celu jego złomowania, należy zdać w odpowiednim punkcie utylizacji odpadów w celu recyklingu komponentów elektrycznych i elektronicznych.

Urządzenie należy złomować zgodnie z lokalnymi przepisami dot. utylizacji odpadów.

Dodatkowe informacje na temat utylizacji, złomowania i recyklingu opisywanego urządzenia można uzyskać w lokalnym urzędzie miasta, w miastach przedsiębiorstwie utylizacji odpadów lub w sklepie, w którym produkt został zakupiony.

**CZ** Tento spotřebič je označený v souladu s evropskou směrnicí 2002/96/ES o likvidaci elektrického a elektronického zařízení (WEEE). Zajištěním správné likvidace tohoto výrobku pomůžete zabránit případným negativním důsledkům na životní prostředí a lidské zdraví, ke kterým by nevhodnou likvidací tohoto výrobku mohlo dojít.

Symbol  na výrobku nebo na dokumentech přiložených k výrobku udává, že tento spotřebič nepatří do domácího odpadu. Spotřebič je nutné odvézt do sběrného místa pro recyklaci elektrického a elektronického zařízení.

Likvidace musí být provedena v souladu s místními předpisy o ochraně životního prostředí, které se týkají likvidace odpadu.

Podrobnější informace o zpracování, recuperaci a recyklaci tohoto výrobku zjistíte u příslušného místního úřadu, služby pro likvidaci domovního odpadu nebo v obchodě, kde jste výrobek zakoupili.

**SK** Tento spotřebič je označený v súlade s Európskou smernicou 2002/96/ES o likvidácii elektrických a elektronických zariadení (WEEE). Zabezpečením, že tento výrobok bude zlikvidovaný správnym spôsobom, pomôžete predchádzať potenciálnym negatívnym dopadom na životné prostredie a ľudské zdravie, ktoré by sa v inom prípade mohli vyskytnúť pri nevhodnom zaobchádzaní pri likvidácii tohto výrobku.

Symbol  na výrobku alebo na sprievodných dokumentoch znamená, že tento výrobok sa nesmie zaobchádzať ako s domovým odpadom. Naopak, treba ho odovzdať v zbornom stredisku na recykláciu elektrických alebo elektronických zariadení.

Likvidácia musí byť vykonaná v súlade s predpismi na ochranu životného prostredia pre likvidáciu odpadov.

Podrobnejšie informácie o zaobchádzaní, regenerácii a recyklácii tohto výrobku si vyžiadajte na Vašom miestnom úrade, v zberných surovinách alebo v obchode, kde ste výrobok kúpili.

**H** A készüléket található jelzés megfelel az elektromos és elektronikus berendezések hulladékairól szóló 2002/96/EK európai irányelvben (WEEE) foglalt előírásoknak.

A hulladékát vált termékek szabályszerű elhelyezésével Ön segít elkerülni a környezet és az emberi egészséggel kapcsolatos az esetleges negatív következményeket, amelyeket a termék nem megfelelő hulladékkezelése egyébként okozhatna.

A termékem vagy a termékhez mellékelt dokumentumokon feltüntetett  jelzés arra utal, hogy ez a termék nem kezelhető háztartási hulladékként. Ehelyett a terméket a villamos és elektronikus berendezések újrahasznosítását végző telephelyek valamelyikén kell leadni.

Kiselejtezőskor a hulladéktalálótásra vonatkozó helyi környezetvédelmi előírások szentet kell eljáráni.

A termék kezelésével, hasznosításával és újrahasznosításával kapcsolatos bővebb tájékoztatásért forduljon a lakohelye szerinti polgármesteri hivatalhoz, a háztartási hulladékok kezelését végző társasághoz vagy ahhoz a bolthoz, ahol a terméket vásárolta.

**RUS** Данное изделие промаркировано в соответствии с Европейской директивой 2002/96/EC по утилизации электрического и электронного оборудования (WEEE).

Обеспечив правильную утилизацию данного изделия, Вы сможете предотвратить потенциальные негативные последствия для окружающей среды и здоровья человека, которые могли бы иметь место в противном случае.

Символ  на самом изделии или сопроводительной документации указывает, что при утилизации данного изделия с ним нельзя обращаться как с обычными бытовыми отходами.

Вместо этого, его следует сдавать в соответствующий пункт приема электрического и электронного оборудования для последующей утилизации.

Сдача на слом должна производиться в соответствии с местными правилами по утилизации отходов.

За более подробной информацией о правилах обращения с такими изделиями, их утилизации и переработки обращайтесь в местные органы власти, в службу по утилизации отходов или в магазин, в котором Вы приобрели данное изделие.

**BG** Този уред е маркиран в съответствие с Европейска директива 2002/96/EC (Електрическо и електронно оборудване за отпадък).

Като се грижите това изделие да бъде изхвърлено по правлен начин, вие ще помогнете за предотвратяване на възможните негативни последици за околната среда и здравето на хората, което в противен случай може да бъде предизвикано от неправилно изхвърляне на това изделие.

Символът  върху изделието или върху документите, приложено к изделието, показва, че това изделие не бива да се третира като битови отпадък. Вместо това, то трябва да се предава в специализиран пункт за рециклиране на електрическо и електронно оборудване.

При изхвърлянето му спазвайте местните норми за изхвърляне на отпадъци.

За по-подробна информация за третирането, възстановяването и рециклирането на това изделие се обърнете към вашата местна градска управа, към вашата служба за изхвърляне на битови отпадъци или към магазина, откъдето сте закупили изделието.

**RO** Acest aparat este marcat în conformitate cu Directiva Europeană 2002/96/CE referitoare la Deseurile de Echipament Electric și Electronic (WEEE).

Asigurându-vă că acest produs este eliminat în mod corect, contribuiți la prevenirea potențialelor consecințe negative asupra mediului înconjurător și sănătății persoanei, consecințe care ar putea fi provocate de aruncarea necorespunzătoare la gunoi a acestui produs.

Simbolul  de pe produs, sau de pe documentele care însoțesc produsul, indică faptul că acesta nu poate fi aruncat împreună cu deeurile menajere. Trebuie predat la punctul de colectare corespunzător, pentru reciclarea echipamentului electric și electronic.

Aruncarea la gunoi a aparatului trebuie făcută în conformitate cu normele locale pentru eliminarea deeurilor.

Pentru informații mai detaliate privind eliminarea, valorificarea și reciclarea acestui produs, sau numai să contactați administrația locală, serviciul de eliminare a deeurilor menajere sau magazinul de unde ați cumpărat produsul.









**COD. H01A374G**